

3-01



3-06

3-02

3-08



3-04



3-06



3-10

3-09



3-03

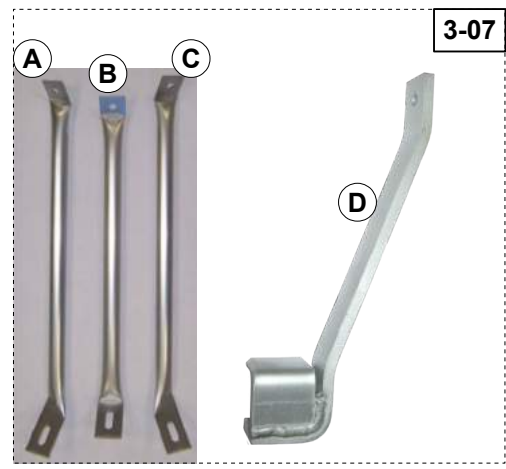

3-07

3-05 x2



3-11

3-12



3-13

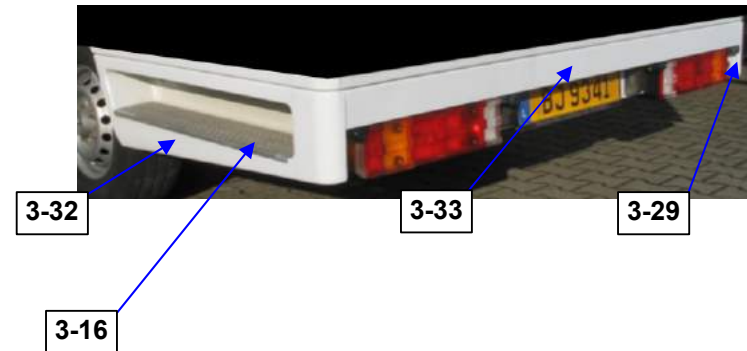
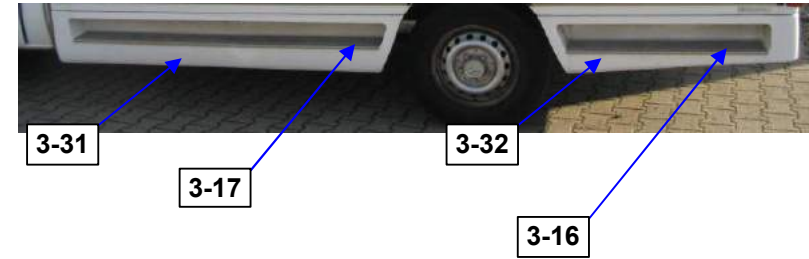
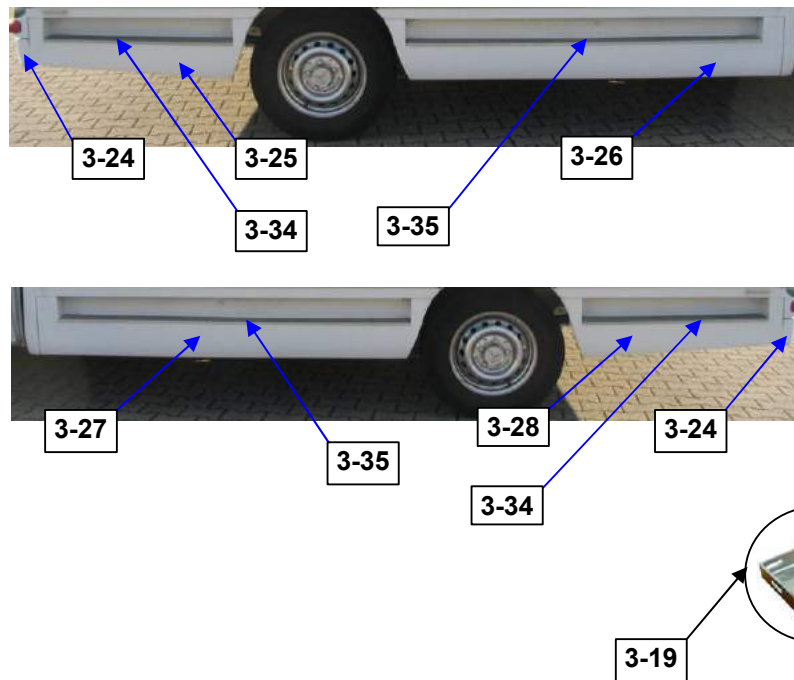
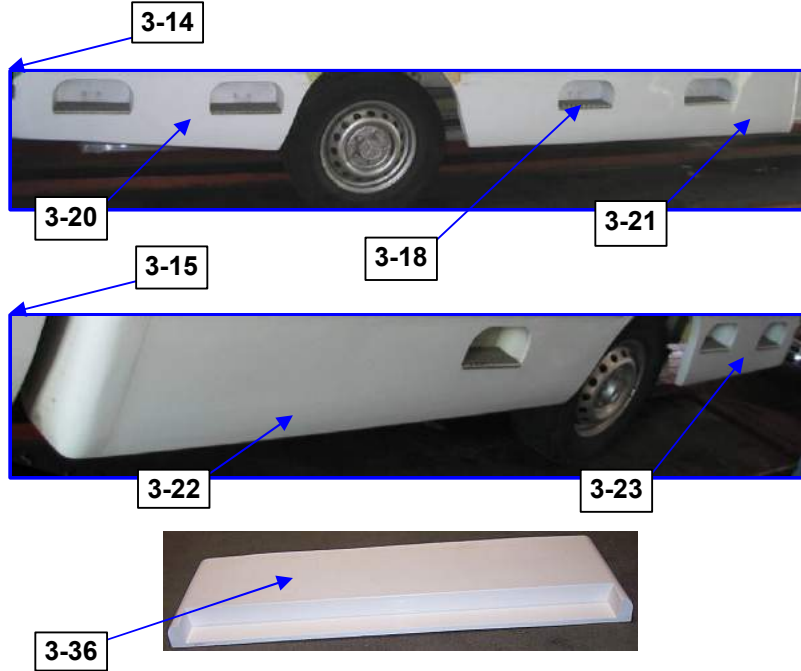

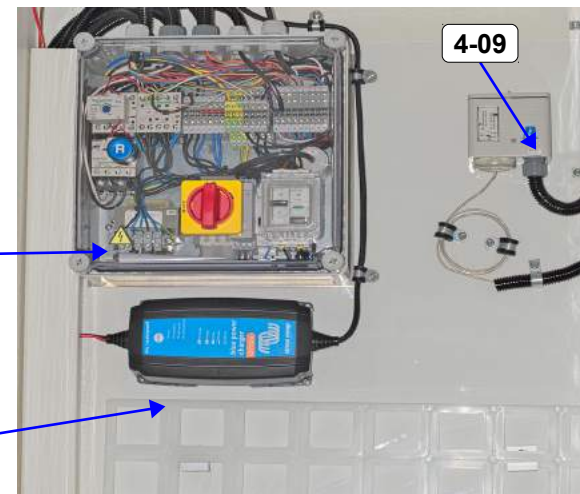
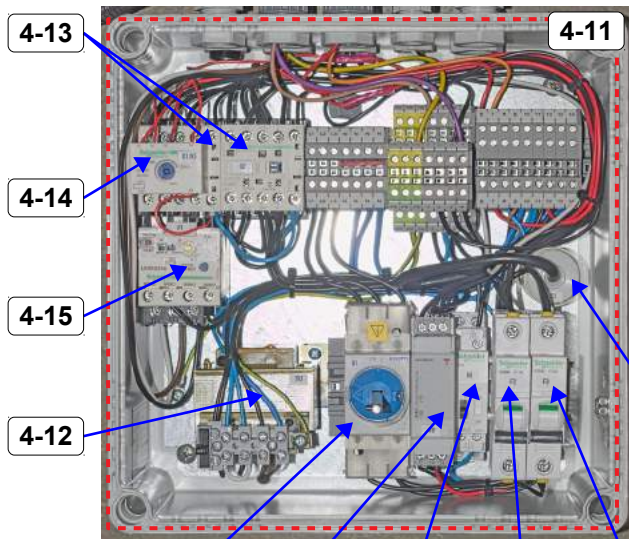
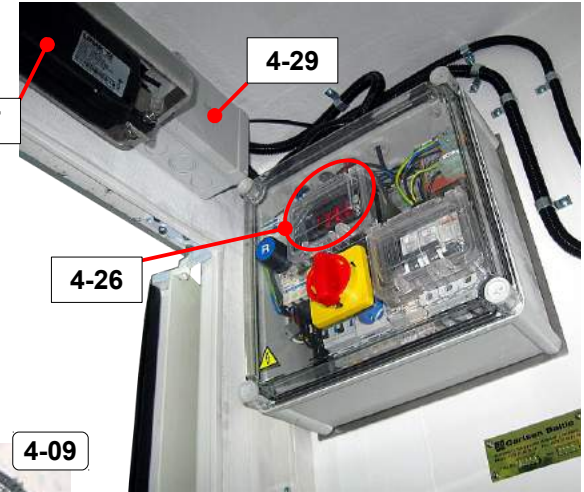

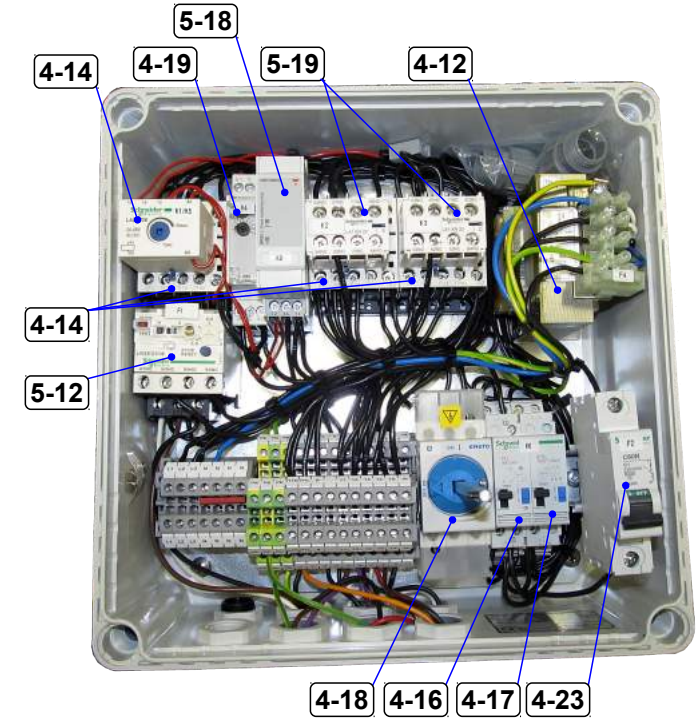
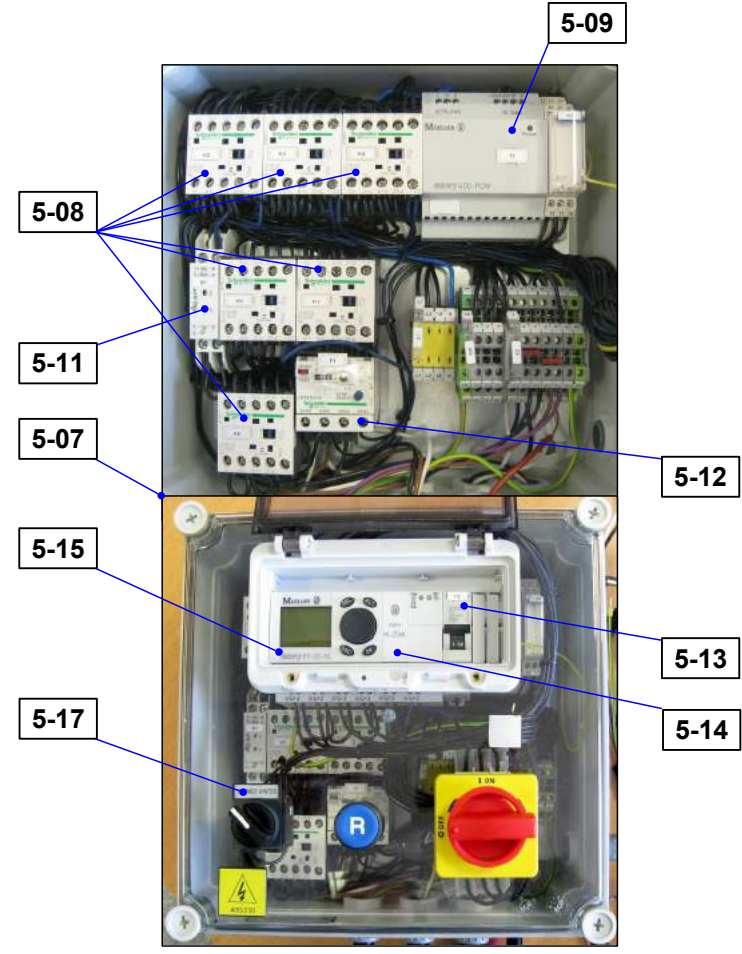
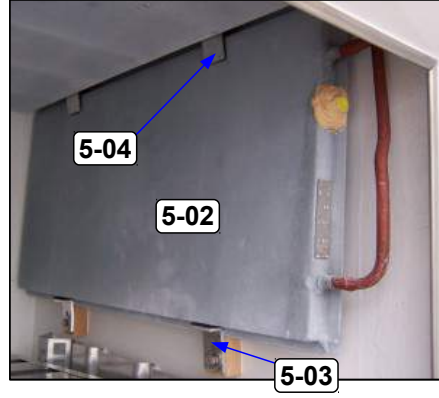
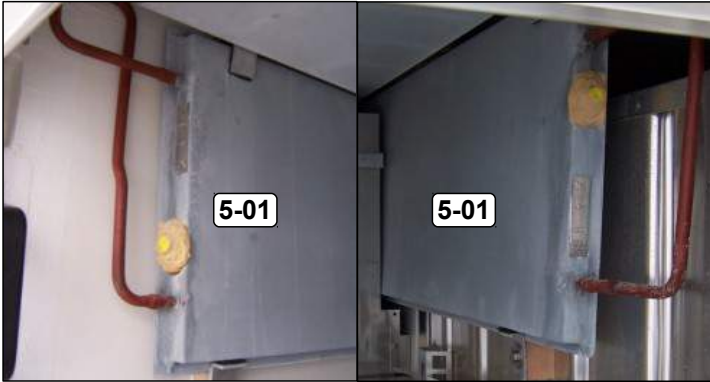

1. Outer components

| Description | Part No. Carlsen | Part No. Customer | Position on picture |
|---|----------------------|-------------------|---------------------|
| Door lock without cylinder (painted white surface finishing) | 10001-01 | | 1-01 |
| Door lock without cylinder (stainless steel surface finishing) | S0077 | | |
| Door lock including cylinder (stainless steel surface finishing) | 10243 | | |
| Key blank HD | S0022 | 700056638 | 1-16 |
| Key (code required) | S0012 | 700056638 | |
| Locking cylinder (set of 10 cylinders) | 10908 or 10001-02 | 700056636 | 1-12 |
| Door retainers complete set | S0097 | | 1-02 |
| Door retainer, male | 10066 | 1 | |
| Door retainer, female | 10067 | 1 | |
| Pad for door retainer 4x25x57mm PVC | 10079 | 1 | |
| Pad for door retainer 4x25x67mm PVC | 10080 | 1 | |
| Door, freezer, ass'y | 110005 | 700056610 | 1-03 |
| Door painting | | | |
| Thermometer, external | 10094 | 700056291 | 1-04 |
| Bracket for door retainer complete | | 700061388 | 1-05 |
| Bracket for door retainer | 102190 | 1 | |
| Door retainer, male | 10066 | 1 | |
| Top rain strip with holes | 102352 | | 1-06 |
| Stop piece for basketrail | 100274 | 700056672 | 1-07 |
| Basket rail with holes (3600 mm) | 100273 | 700056301 | 1-08 |
| End piece, black | 10065 | 700056673 | 1-09 |
| Plastic insert strip 40 mm red (Price/Meter) | 10193 | | 1-10 |
| Plastic insert strip 40 mm black (Price/ Meter) | 10235 | | |
| Plastic insert strip 40 mm blue cut in 4 m pieces | 10193 | 700056298 | |
| 40 mm rear protection strip Sprinter/VW 970 mm long | 101076 | | 1-11 |
| 40 mm rear protection strip Iveco 1139 mm long | 101421 | | |
| 40 mm rear protection strip 1040 mm lang | 101184 | | |
| 40 mm front protection strip MB/VW 1785 mm long | 101080 | | 1-13 |
| 40 mm front protection strip Iveco 16155 mm long | 101422 | | |
| 40 mm front protection strip 1835 mm long | 101183 | | |
| 40 mm protection strip 4 m long | S0011 | 700056299 | 1-11 & 13 |
| Bracket for sidemarking light | 102072 | | 1-14 |
| Side lamp 12V diode yellow | 12008 | 700061204 | 1-15 |
| Side lamp 12V for incandescent bulb, yellow | 11085 | | |
| Rear bumper, blue; complete | | 700056682 | 1-17 |
| Rear bumper, blue; central piece | 100434-03 | 1 | |
| Rear bumper, blue; corner piece (left/right) | 100429-03 | 2 | |
| Rear bumper, blue; central piece | 100434-03 | 700061205 | |
| Rear bumper, blue; corner piece (left/right) | 100429-03 | 700061206 | |
| Rear bumper, red; central piece | 100434-04 | | |
| Rear bumper, red; corner piece (left/right) | 100429-04 | | |
| Rear bumper, black; central piece | 11280 | | |
| Rear bumper, black; corner piece (left/right) | 11281 | | |
| Bumper plug, blue | 10219 | | |
| Bumper plug, black | 10244 | | |
| Lamp number plate complete | S0098 | | 1-19 |
| Lamp number plate | 10049 | 1 | |
| Lamp 12V 5W BA 15s | 10050 | 1 | |
| Rafi bulb 24V 50mA | 13258 | | 1-18 |
| Green control lamp, complete | | 700060272 | 1-20 |
| Lens green | 11352 | 1 | |
| Rafi lamp socket | 11351 | 1 | |
| Rafi bulb 24V 50mA | 13258 | 1 | |
| Spacer for Rafi lens | 13259 | 1 | |
| CEE connector | 10355 | | 1-21 |
| Front grill | 101656 | | 1-22 |
| Perforated sheet | 101770 | | 1-23 |

1. Outer components

| Description | Part No. Carlsen | Part No. Customer | Position on picture |
|--|------------------|-------------------|---------------------|
| Engine compartment door Door painting | 110006 | 700056611 | 1-24 |
| LED braking light external, mounted on the surface of rear panel | 10440 | | 1-25 |
| LED braking light inserted in the rear panel | 10264 | | |

2. Inner components

| Description | Part No. Carlsen | Part No. Customer | Position on picture |
|---|------------------|-------------------|---------------------|
| Central locking device complete | | 700056692 | |
| Transverse rod for central locking system | 100517 | 1 | |
| Central locking device, left side | 101189 | 1 | 2-01 |
| Central locking device, right side | 101188 | 1 | |
| Tube POM | 101047 | 1 | |
| Eutectic plate 1660x630x24, zinc coated | 111765 | | |
| Eutectic plate 1660x630x24, stainless steel | 102436 | 700056700 | 2-02 |
| Eutectic plate 1660x630x24 for 2,4 kg cooling system, stainless steel | 102582 | | |
| Shelf for freezing compartment | 100037 | 700056675 | 2-03 |
| Shelf support for freezing compartment | 100038 | 700056680 | 2-04 |
| Partition transverse - 1740x1080 | 101777 | | |
| Partitions transverse - 1740x965 | 101778 | | 2-05 |
| Partition transverse - 820x1080 | 101009 | | |
| Partition lengthwise center - 640x1080 | 100253 | | 2-06 |
| Rests, freezing compartment floor | 10014 | | 2-07 |
| Rests, freezing compartment floor, set (23pcs) | | 700056674 | |
| Compressor room gratings | 13218 | | 2-28 |
| Handle, short | 100980 | | 2-08 |
| Eutectic plate 770x688x24, zinc coated | 111077 | 700056701 | |
| Eutectic plate 770x630x24, stainless steel | 102437 | | 2-10 |
| Eutectic plate 770x630x24 for 2,4 kg cooling system, stainless steel | 102583 | | |
| Ladder 28x666 mm | 101773 | | 2-11 |
| Ladder 37x660 mm | 101774 | | |
| Thermometer, inner with bracket | | 700056705 | |
| Thermometer, inner without bracket | 10084 | 1 | 2-12 |
| Bracket for inner thermometer | 10086 | 1 | |
| Shelf for engine compartment 650 mm width | 101874 | | |
| Shelf for engine compartment perforated 630 mm width | 102235 | | 2-13 |
| Shelf support for engine compartment right long | 100235 | | |
| Shelf support for engine compartment, left long | 101850 | | |
| Shelf support for engine compartment, right short | 102238 | | 2-14 |
| Shelf support for engine compartment, left short | 102248 | | |
| Rear shelf support for engine compartment short | 102233 | | |
| Door stopper triangle | 101669 | | 2-15 |
| Holder for central locking device; right side | 101079 | 700056694 | 2-16 |
| Holder for central locking device; left side | 101082 | 700056695 | |
| Inner weatherstrip 1019x624 | 10380 | 700056630 | 2-17 |
| Outer weatherstrip 1041x646 | 10379 | 700056631 | 2-18 |
| Hand lever for central locking system | 10024 | 700056691 | 2-31 |
| Hand lever for central locking system complete (mechanical) | | 700056691 | |
| Hand lever for central locking system | 10024 | 1 | 2-20 |
| Extension rod for central lock | 101048 | 1 | |
| Console for hand lever | 101198 | 1 | |

2. Inner components

| Description | Part No. Carlsen | Part No. Customer | Position on picture |
|---|------------------|-------------------|---------------------|
| Tube of central lever | 102232 | 700056693 | 2-27 |
| Drenage complete | | 700061390 | |
| Nylonbush for drain | 101293 | 1 | 2-21 |
| Gasket for drain | 100906 | 1 | |
| Spring f. drain | 100907 | 1 | |
| Bracket for drain | 101799 | 1 | |
| Locking bracket last doors, Nylon | 100294 | 700056641 | |
| Locking bolt with cone | 100334 | 700056640 | 2-23 |
| End plate for lock | 100179 | 700056634 | 2-29 |
| Hinge, on doors, left female | 100353-01 | 1 | 2-24 & 25 |
| Hinge, on doors, right female | 100354-01 | 1 | |
| Hinge, left male | 100351-01 | 1 | |
| Hinge, right male | 100352-01 | 1 | |
| Set of hinges | | 700056621 | |
| Hinge, on doors, left female | 100353-01 | 1 | |
| Hinge, left male | 100351-01 | 1 | |
| Screw - Taptite 5x16 w. washer | 10088 | 8 | |
| Washer for door 12x7x0,8 Nylon | 10318 | 2 | |
| Set of hinges | | 700056622 | |
| Hinge, on doors, right female | 100354-01 | 1 | |
| Hinge, right male | 100352-01 | 1 | |
| Screw - Taptite 5x16 w. washer | 10088 | 8 | |
| Washer for door 12x7x0,8 Nylon | 10318 | 2 | |
| Hinge, mid doors male | 100350-01 | 700056620 | 2-26 |
| Washer for door 12x7x0,8 Nylon | 10318 | 2 | |
| Screw - Taptite 5x16 w. washer | 10088 | 4 | |
| Hinge, left male | 100351-01 | | 2-24 & 25 |
| Washer for door 12x7x0,8 Nylon | 10318 | 2 | |
| Screw - Taptite 5x16 w. washer | 10088 | 4 | |
| Hinge, right male | 100352-01 | | |
| Washer for door 12x7x0,8 Nylon | 10318 | 2 | |
| Screw - Taptite 5x16 w. washer | 10088 | 4 | |
| Hinge, on doors, left female | 100353-01 | 700056623 | |
| Washer for door 12x7x0,8 Nylon | 10318 | 2 | |
| Screw - Taptite 5x16 w. washer | 10088 | 4 | |
| Hinge, on doors, right female | 100354-01 | 700056624 | |
| Washer for door 12x7x0,8 Nylon | 10318 | 2 | |
| Screw - Taptite 5x16 w. washer | 10088 | 4 | |
| Liquid silicone for the weatherstrip care | 10030 | | 2-30 |
| Rail for door frame, short | 100315 | | 2-32 |
| Rail for door frame, long | 100314 | | 2-33 |
| Lamp LED inside lightening x 3 pcs module | 10290 | | 2-34 |
| Lamp LED inside lightening x 2 pcs module | 10291 | | 2-35 |
| Air cooling plate (active) | 10190 | | 2-36 |
| Thermostatic expansion valve TS2 | 11076 | | 2-37 |
| Thermostatic expansion valve TES2 | 11625 | | |
| Thermostatic expansion valve TDS1 | 10885 | | |

3. Steps

| Description | Part No. Carlsen | Part No. Customer | Position on picture |
|-------------------------------|------------------|-------------------|---------------------|
| Alu-steps right side Sprinter | S0093 | | 3-01 |
| Alu-steps left side Sprinter | S0094 | | |
| Alu-steps left side Iveco | S0095 | | |
| Alu-steps right side Iveco | S0096 | | |

3. Steps

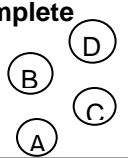
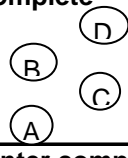
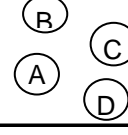
| Description | Part No. Carlsen | Part No. Customer | Position on picture |
|---|------------------|-------------------|---------------------|
| Step right side rear Sprinter/Iveco complete | | 700061190 | |
| Step right side rear Sprinter/Iveco | 102115 | 1 | 3-02 |
| Tubular rivet RH 4.8x18 A2 DIN 7337 | 10139 | 2 | |
| Rear step protection PVC | 102131 | 1 | |
| Step left side rear Sprinter/Iveco complete | | 700061189 | |
| Step left side rear Sprinter/Iveco | 102133 | 1 | 3-02 |
| Tubular rivet RH 4.8x18 A2 DIN 7337 | 10139 | 2 | |
| Rear step protection PVC | 102131 | 1 | |
| Step middle part Sprinter/Iveco complete | | 700061196 | |
| Step middle part Sprinter/Iveco | 102114 | 1 | 3-03 |
| Aluminium pin for steps | 102207 | 2 | |
| Fixer DIN11024 D2-52, zink | 13255 | 2 | |
| Step front left side Iveco | 102135 | 700061192 | 3-04 |
| Step front right side Iveco | 102134 | 700061193 | |
| Step front left side Sprinter | 102132 | 700061187 | |
| Step front right side Sprinter | 102113 | 700061188 | |
| Aluminium pin for steps with fixer | S0099 | | |
| Aluminium pin for steps | 102207 | 1 | 3-05 |
| Fixer DIN11024 D2-52 | 13255 | 1 | |
| Rear step protection PVC complete | S0100 | | |
| Rear step protection PVC | 102131 | 1 | 3-06 |
| Tubular rivet RH 4.8x18 A2 DIN 7337 | 10139 | 2 | |
| Brackets for steps left side Iveco complete | | 700061350 | |
| Bracket for step, ass'y  | 101890 | 5 | 3-07 |
| Support for alu-step | 101892 | 2 | |
| Support for alu-step; angled, left | 101911 | 2 | |
| Support for alu-step, angled, right | 101910 | 1 | |
| Brackets for steps right side Iveco complete | | 700061351 | |
| Bracket for step, ass'y  | 101890 | 5 | 3-07 |
| Support for alu-step | 101892 | 2 | |
| Support for alu-step; angled, left | 101911 | 1 | |
| Support for alu-step, angled, right | 101910 | 2 | |
| Brackets for steps left/right side Sprinter complete | | 700061191 | |
| Support for alu-step  | 101892 | 1 | 3-08 |
| Support for alu-step; angled, left | 101911 | 2 | |
| Support for alu-step, angled, right | 101910 | 2 | |
| Bracket for alu-steps | 102077 | 5 | |
| Splash guard 4370 | 13053 | | 3-08 |
| Alu light rail Sprinter complete, NOT PAINTED | | 700061198 | |
| Light rail Sprinter | 102043 | 1 | 3-09 |
| Support for light rail, Sprinter | 102160 | 2 | |
| Alu-light rail, Iveco complete, NOT PAINTED | | 700060271 | |
| Alu-light rail, Iveco | 101946 | 1 | 3-09 |
| Support for light rail, Iveco | 101912 | 2 | |
| Painting of light rail Sprinter or Iveco, 1 pcs | | | |
| Rear underrun protection Sprinter, NOT painted | 103132-01 | | 3-10 |
| Rear underrun protection Iveco, NOT painted | 103152-01 | | |
| Rear underrun protection Sprinter, PAINTED | 103132-02 | | |
| Rear underrun protection Iveco, PAINTED | 103152-02 | | |
| Support for light rail MB old | 101887 | | 3-10 |
| Support for light rail VW | 102138 | | |
| Support for light rail Sprinter | 102160 | | |
| Support for light rail Iveco | 101912 | | |
| Wheel guard blue | 12400 | 700061197 | 3-11 |
| Wheel guard black | 11001 | | |
| Bracket for wheel guard VW/Sprinter | 102107 | | 3-12 |
| Bracket for wheel guard Iveco | 101925 | | |

| | | | |
|-------------------------------------|--------|--|------|
| Inner bracket for wheel guard Iveco | 101988 | | 3-13 |
|-------------------------------------|--------|--|------|

3. Steps

| Description | Part No. Carlsen | Part No. Customer | Position on picture |
|---|------------------|-------------------|---------------------|
| Right side plastic skirt MB/VW | S0005 | | 3-14 |
| Left side plastic skirt MB/VW | S0004 | | 3-15 |
| Rear non-slip plate for steps with rounded corners | 101648 | | 3-16 |
| Front non-slip plate for steps with rounded corners | 101613 | | 3-17 |
| Non-slip plate for steps (small) | 100217 | 700056653 | 3-18 |
| Brackets for plastic skirt complete | | 700056668 | |
| Triangle bracket for plastic skirt | 101095 | 1 | 3-19 |
| Angle bracket with round hole | 101154 | 1 | |
| Plastic step, rear right, MB/VW | 10482 | 700056664 | 3-20 |
| Plastic step, rear right, Iveco | S0042 | 700056654 | |
| Plastic step, front right, MB/VW | S0038 | 700056660 | 3-21 |
| Plastic step, front right, Iveco | S0041 | 700056650 | |
| Plastic step, front left, MB/VW | S0036 | 700056661 | 3-22 |
| Plastic step, front left, Iveco | S0039 | 700056651 | |
| Plastic step, rear left, MB/VW | S0037 | 700056665 | 3-23 |
| Plastic step, rear left, Iveco | S0040 | 700056655 | |
| Plastic skirt rear end MB/Iveco | 101161 | 700056658 | 3-24 |
| Plastic side skirt, rear, right, MB/VW | 101113 | 700056666 | 3-25 |
| Plastic side skirt, rear, right, Iveco | 101307 | 700056656 | |
| Plastic side skirt front, right, MB/VW | 101107 | 700056662 | 3-26 |
| Plastic side skirt front, right, Iveco | 101306 | 700056648 | |
| Plastic side skirt, front, left, MB/VW | 101112 | 700056663 | 3-27 |
| Plastic side skirt, front, left, Iveco | 101308 | 700056649 | |
| Plastic side skirt rear, left, MB/VW | 101108 | 700056667 | 3-28 |
| Plastic side skirt rear, left, Iveco | 101309 | 700056657 | |
| Plastic side skirt rear right with rounded corner MB | 101480 | | 3-29 |
| Plastic side skirt front right with rounded corner MB | 101479 | | 3-30 |
| Plastic side skirt front left with rounded corner MB | 101477 | | 3-31 |
| Plastic side skirt rear left with rounded corner MB | 101478 | | 3-32 |
| Plastic skirt rear end with round corners MB | 101481 | | 3-33 |
| Non-skid plate, bent, short, rear MB/VW | 101072 | 700056646 | 3-34 |
| Non-skid plate, bent, short, rear Iveco | 101382 | | |
| Non-skid plate, bent, long, front MB/VW | 101071 | 700056647 | 3-35 |
| Non-skid plate, bent, long, front Iveco | 101381 | | |
| Plastic skirt rear | 10483 | | 3-36 |

4. Cooling system components

| Description | Part No. Carlsen | Part No. Customer | Position on picture |
|--|------------------|-------------------|---------------------|
| Condenser ø380 mm ECO | 13231 | | 4-01 |
| Condenser ø428 mm ECO | 12161 | | |
| Diffuser Ø428 | 102933 | | |
| Diffuser Ø360 | 102934 | | |
| Start regulator KVL 22 | 10032 | | 4-02 |
| High pressure switch Danfos ACB 24B422W | 12186 | 700056769 | 4-03 |
| Low pressure switch | 11814 | | 4-04 |
| Filter drier DML 163 | 11374 | | 4-05 |
| Humidity indicator SGI 10s | 10028 | | 4-06 |
| Service valve 6mm | 10159 | | 4-07 |
| Compressor ZF09-K4E-TFD-556 incl. DTC valve | 10119 | | 4-08 |
| Compressor ZF11-K4E-TFD-556 incl. DTC valve | 10329 | | |
| Thermostat, Ranco 016-6950-35 | 10062 | | 4-09 |
| Fan EB M S4D350-AT24-52 120W ø380 mm complete | 12052 | 700056715 | 4-10 |
| Spacer bush for ventilator | 101708 | 4 | |
| Washer M6 A2 DIN 9021 | 10117 | 4 | |
| Screw M6.3x38 FZB DIN7976 | 12162 | 4 | |
| Fan VIP ø420 mm 2-speed 1 Phase | 12051 | | |
| Fan Ziehl Abegg ø420 mm | 10328 | | |

| | | | |
|------------------|-------|-----------|--|
| Fan AC 40-4PL 30 | S0017 | 700056340 | |
|------------------|-------|-----------|--|

4. Cooling system components

| Description | Part No. Carlsen | Part No. Customer | Position on picture |
|---|------------------|-------------------|---------------------|
| Control unit | 12366 | 700056760 | 4-11 |
| Transformator ITR 704 157 24 volt | S0009 | 700061203 | 4-12 |
| Contacto 9A 24V 50/60Hz LC1K0910B7 | S0031 | 700056765 | 4-13 |
| Time delay block LA2KT2E Telemecanique 24-48V 1-30s | S0032 | 700056766 | 4-14 |
| Thermal Overload Relay Telemecanique LR2K0312 | S0030 | 700056764 | 4-15 |
| Relay Merlin Gerin multi 9 TLI 16A, 24V AC, 12V DC | S0027 | 700056767 | 4-16 |
| Relay Merlin Gerin multi 9 ETL 16A, 24V AC, 12V DC | S0019 | 700056767 | 4-17 |
| Load break switch ENSTO KS 13.40 | S0034 | | 4-18 |
| RTH time delay relay Product Ref.: 16065 | S0008 | | 4-19 |
| Control Relay RM4TG20 220-440Vac 50/60Hz | S0018 | | 4-20 |
| Capacitor 6µF ±5% EN60252 400/450Vac | S0033 | | 4-21 |
| Circuit breaker C60N C6 1P 6A | S0029 | | 4-22 |
| Circuit breaker C60N C1 1P 1A | S0028 | | 4-23 |
| Extension cable | 10386 | | 4-24 |
| Insulation for compressor room doors | S0053 | | 4-25 |
| Controller EKC 315A | 10143 | | 4-26 |
| Linear actuator | 10382 | | 4-27 |
| Battery charger 12V/10A | 11036 | | 4-28 |
| Central lock receiver | 10418 | | 4-29 |
| Thermostat RT 9 | 11442 | | 4-30 |
| DTC valve | 10619 | | 4-31 |
| Reset button | S1012 | | 4-32 |
| Main switch handle | S1013 | | 4-33 |
| Discharge gas temperature protection | S1014 | | 4-34 |

5. Eutectic plates

| Description | Part No. Carlsen | Part No. Customer | Position on picture |
|--|------------------|-------------------|---------------------|
| Eutectic plate 1480x400x25 stainless steel | 102835 | | 5-01 |
| Eutectic plate 770x400x25 stainless steel | 102840 | | 5-02 |
| Eutectic plate 770x580x24, stainless steel | 100312-01 | | |
| Eutectic plate 1660x580x24, stainless steel | 100306-01 | | |
| Eutectic plate mounting bracket | 101740 | | 5-03 |
| Eutectic plate mounting bracket | 101739 | | 5-04 |
| Eutectic plate 630x400x24 stainless steel for 5 T body | 102610 | | 5-05 |
| Eutectic plate 970x630x24 stainless steel for 5 T body | 102609 | | 5-06 |
| Control unit FTS-12035_EASY | 12035 | | 5-07 |
| Control unit (2 speeds fan) | 10519 | | |
| Contacto 24V Telemecanique LP4K0901BW3 | S0026 | | 5-08 |
| Transformer EASY400-POW | S0024 | | 5-09 |
| Transmitter INOR APAQ-3LPT | S0057 | | 5-11 |
| Thermal overload relay Telemecanique LR2K0314 | S0056 | | 5-12 |
| Circuit breaker multi 9 Merlin Gerin C60N C2 1P 2A | S0058 | | 5-13 |
| Memory module for EASY 800 | S0025 | | 5-14 |
| Control relay EASY819-DC-RC | S0002 | | 5-15 |
| Summer/Winter switch Telemecanique ZBE-101 | S0060 | | 5-17 |
| Phase monitor relay DPA01CM44 | S0076 | | 5-18 |
| Auxilar contacts LA1KN22 | S0086 | | 5-19 |
| Shelf | 103057 | | 5-20 |
| | 103061 | | |